

ENGINE ELECTRICAL SYSTEM

WIRING SYSTEM

6. RHD DOHC TURBO MODEL

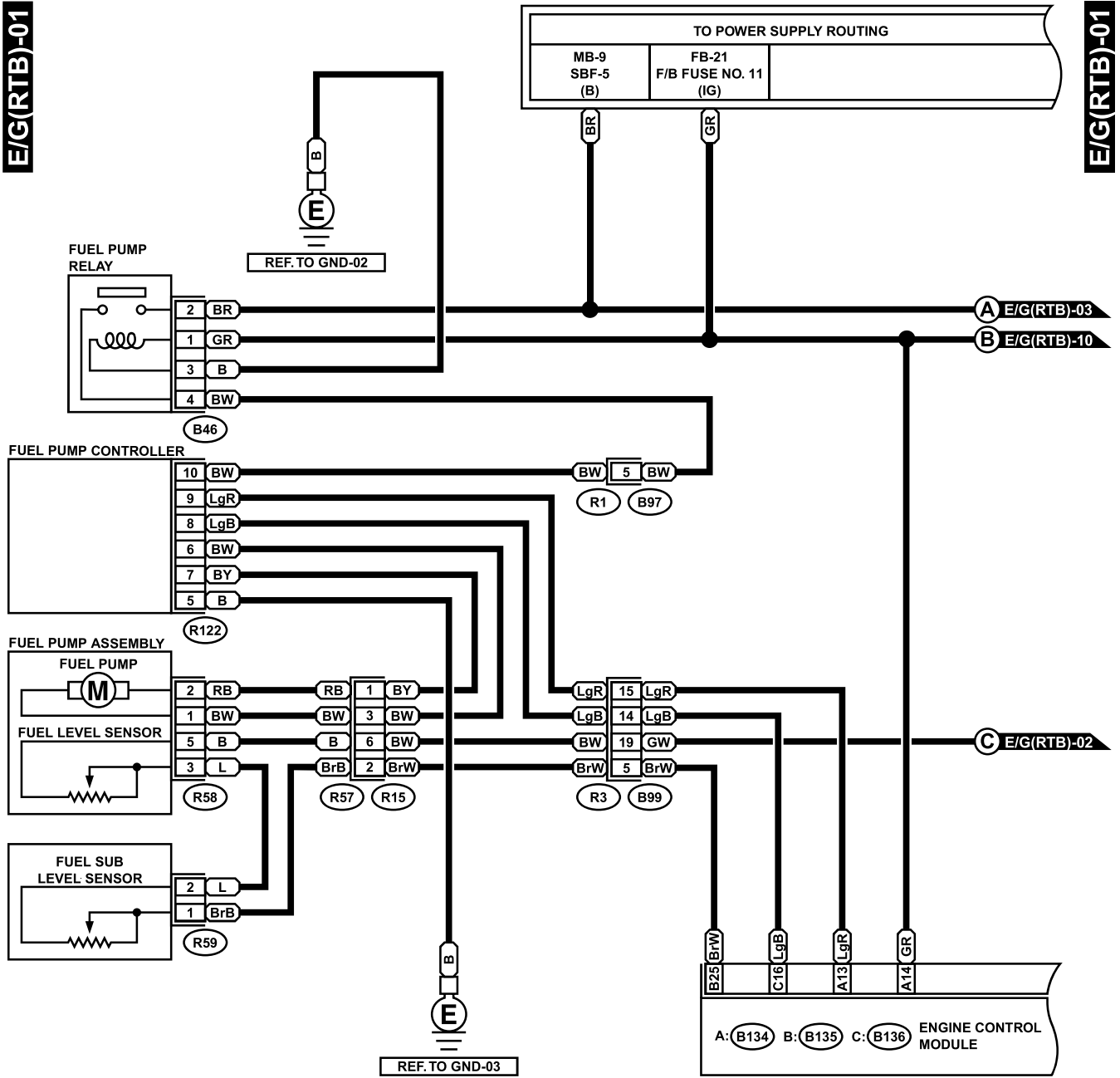

R59



B46 (GREEN)



R57 (BLACK)



R58



B97



R122

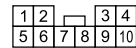

A: B134

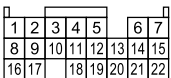

C: B136

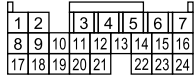

B99

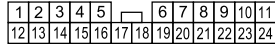

B: B135

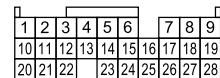

GR10-21A

ENGINE ELECTRICAL SYSTEM

WIRING SYSTEM

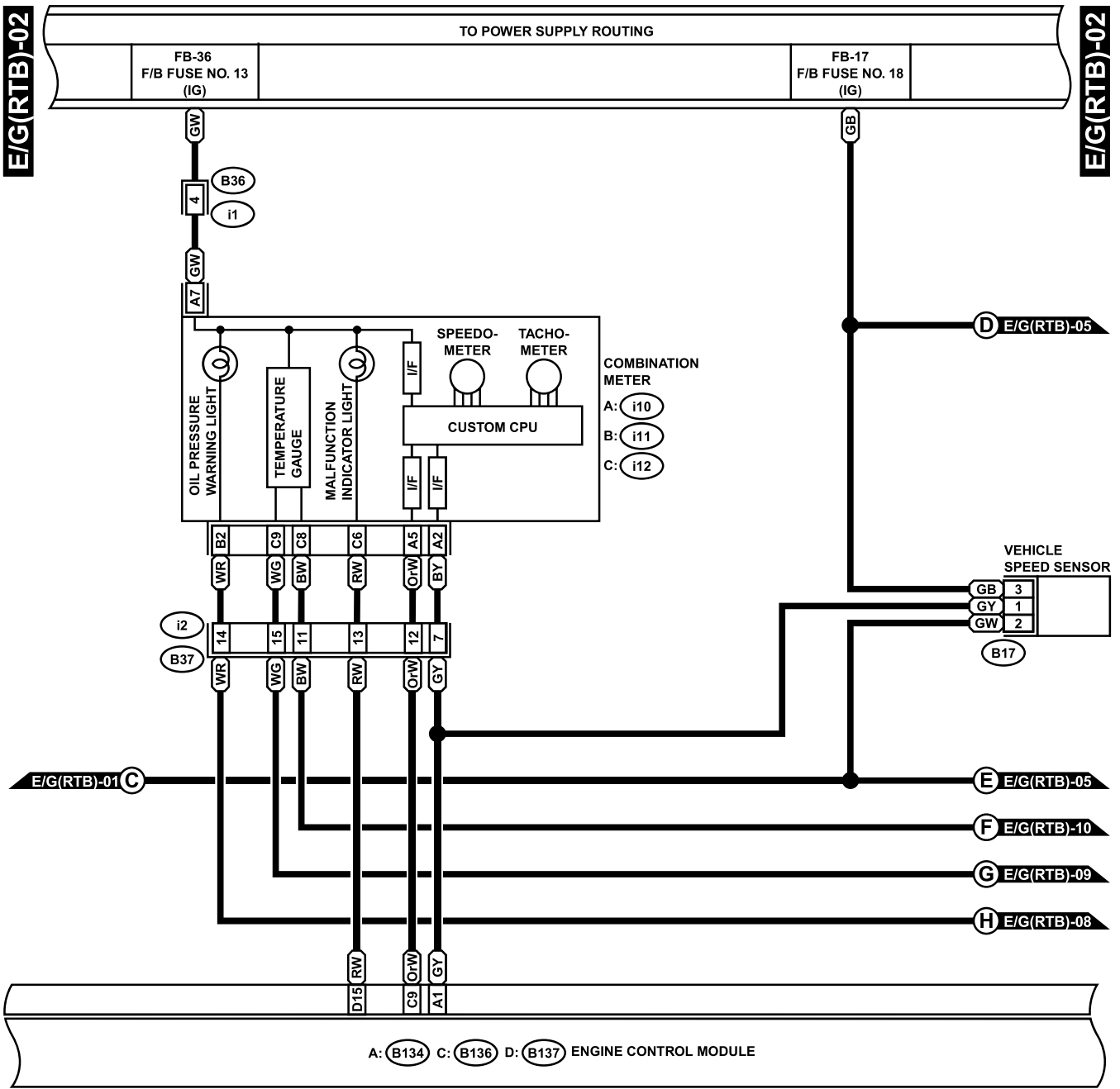

B17

C: i12 (GREEN)

B: i11 (GREEN)

A: i10 (GREEN)

i1 (BLACK)

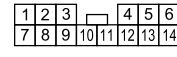
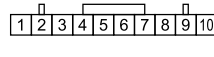
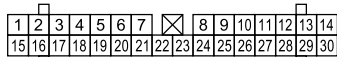
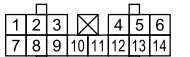

i2

A: B134

C: B136

D: B137

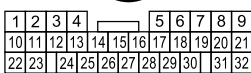

GR10-21B

ENGINE ELECTRICAL SYSTEM

WIRING SYSTEM

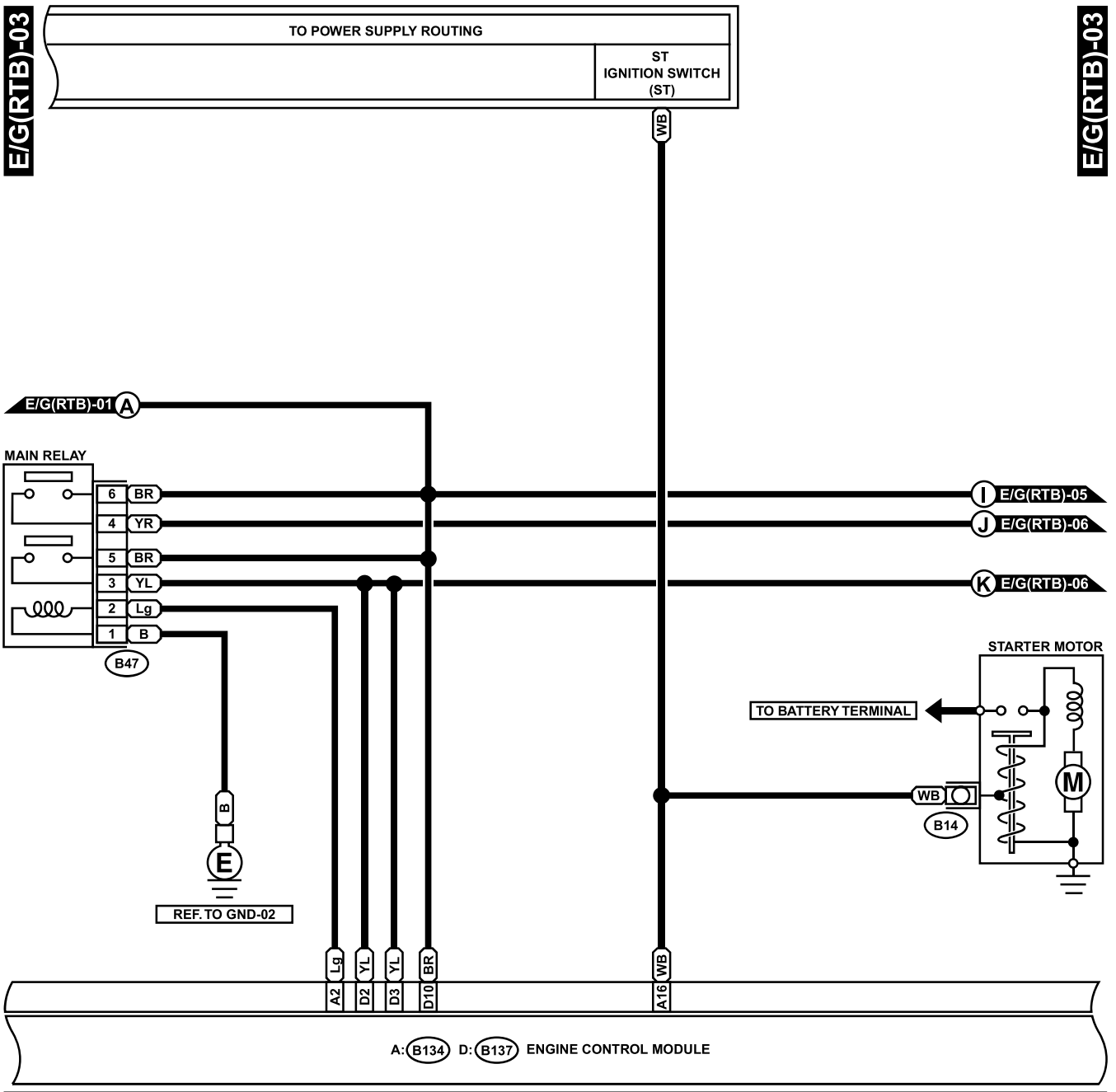

B47 (BROWN)

1	2
3	4
5	6

A: **B134**

1	2	3	4	5	6	7	
8	9	10	11	12	13	14	15
16	17	18	19	20	21	22	

D: **B137**

1	2	3	4	5	6	7	8	9			
10	11	12	13	14	15	16	17	18	19	20	21
22	23	24	25	26	27	28	29	30	31		

GR10-21C

ENGINE ELECTRICAL SYSTEM

WIRING SYSTEM

E/G(RTB)-04

E/G(RTB)-04

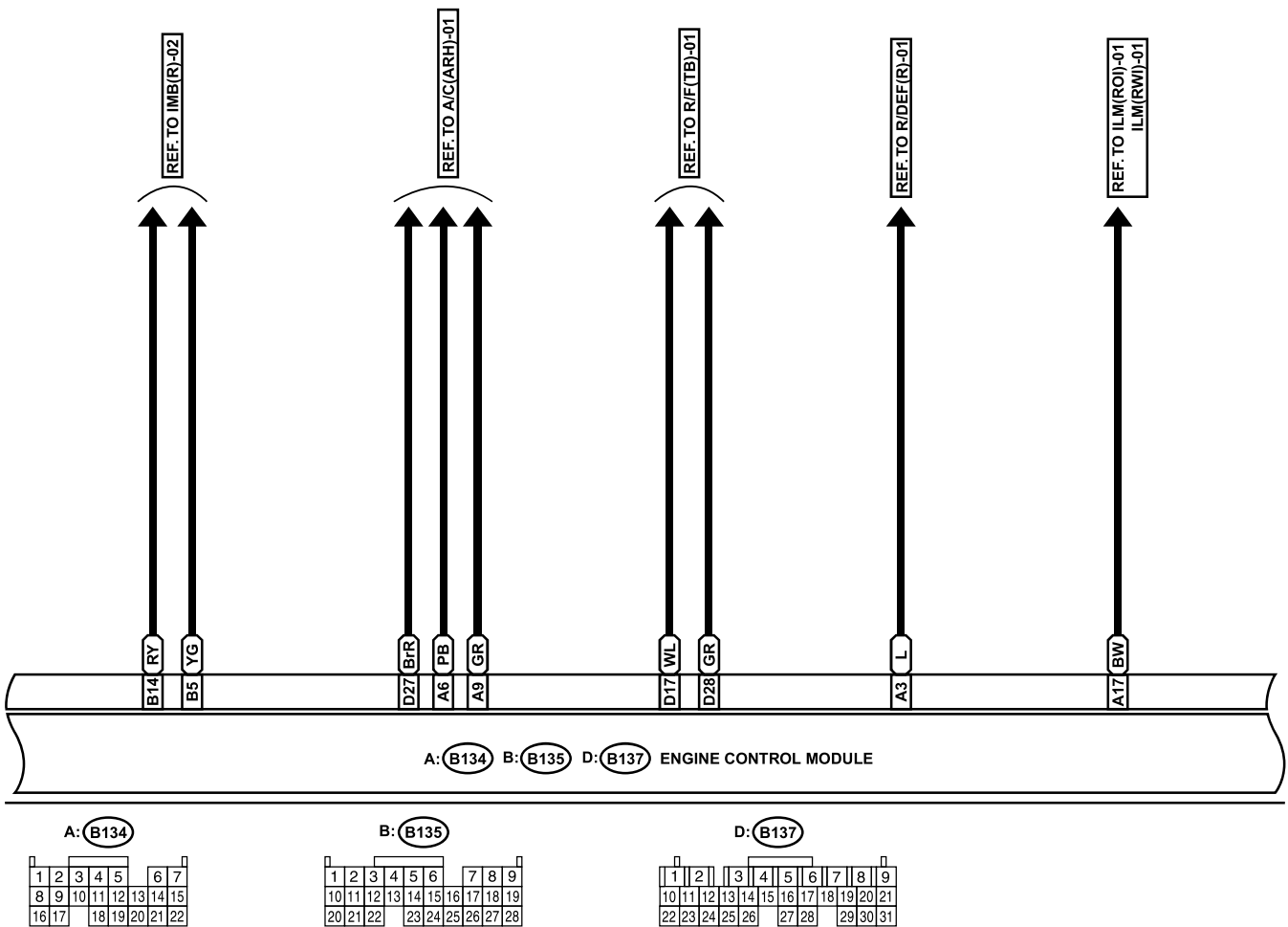

GR10-21D

ENGINE ELECTRICAL SYSTEM

WIRING SYSTEM

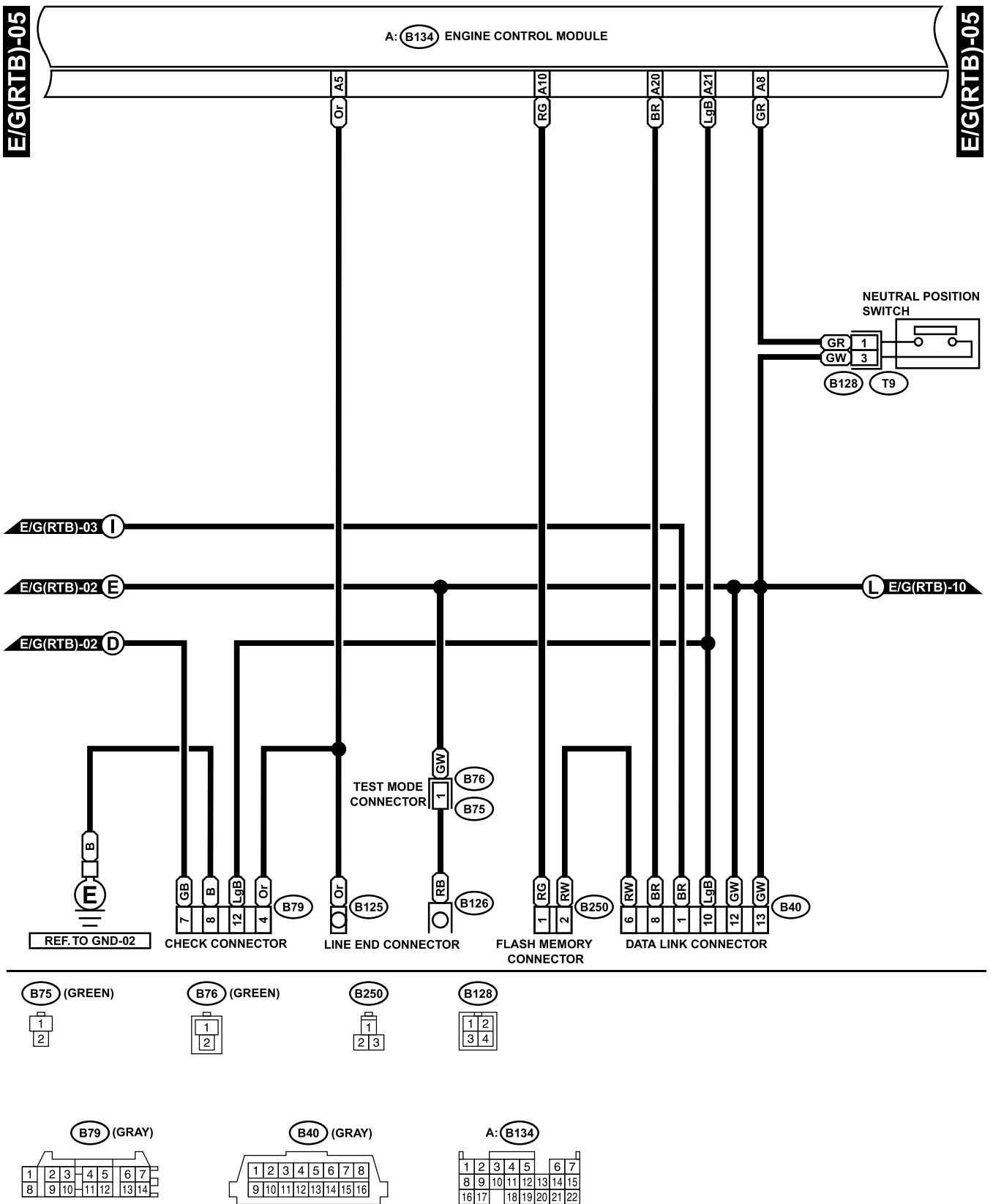

GR10-21E

ENGINE ELECTRICAL SYSTEM

WIRING SYSTEM

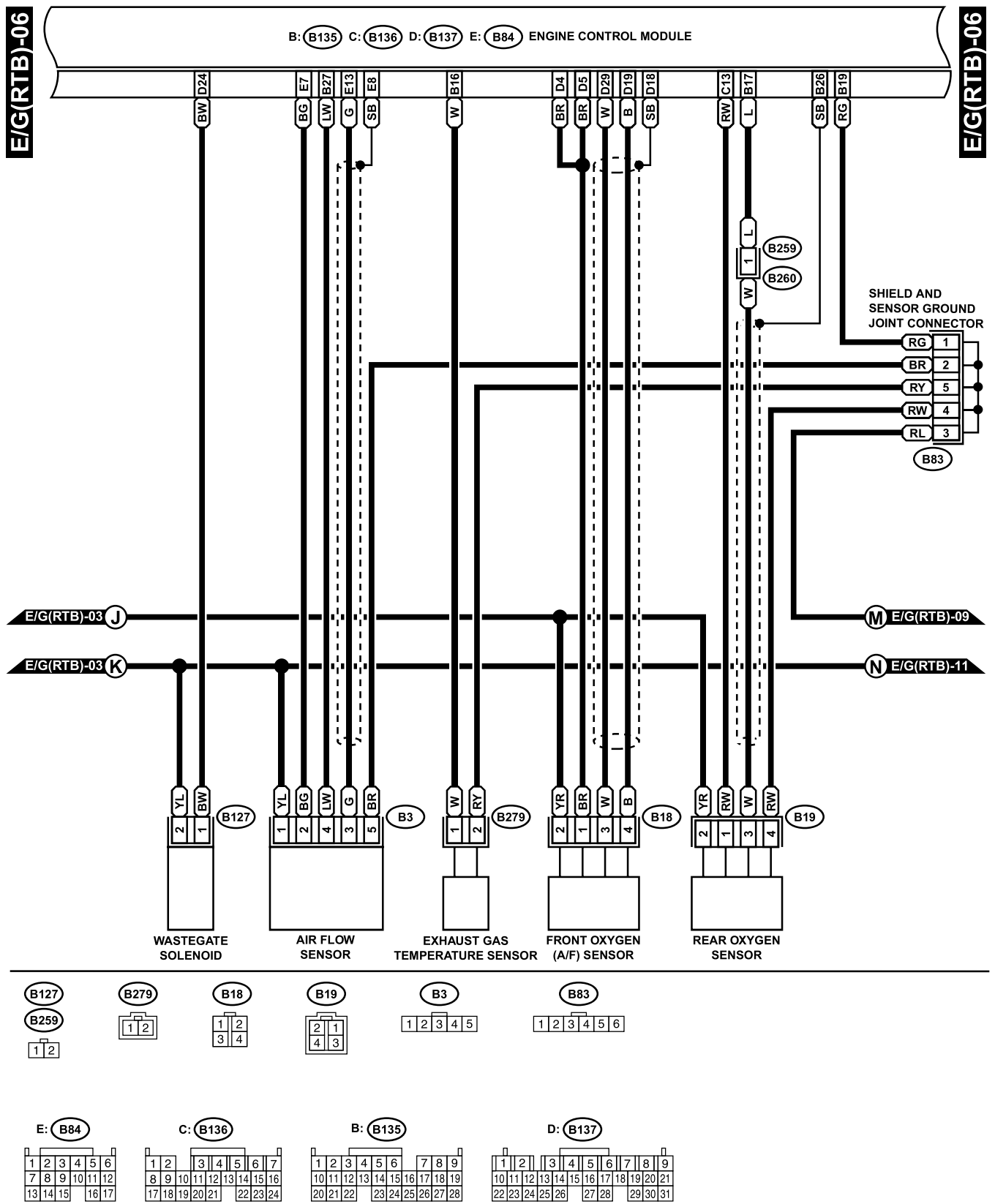

GR10-21F

ENGINE ELECTRICAL SYSTEM

WIRING SYSTEM

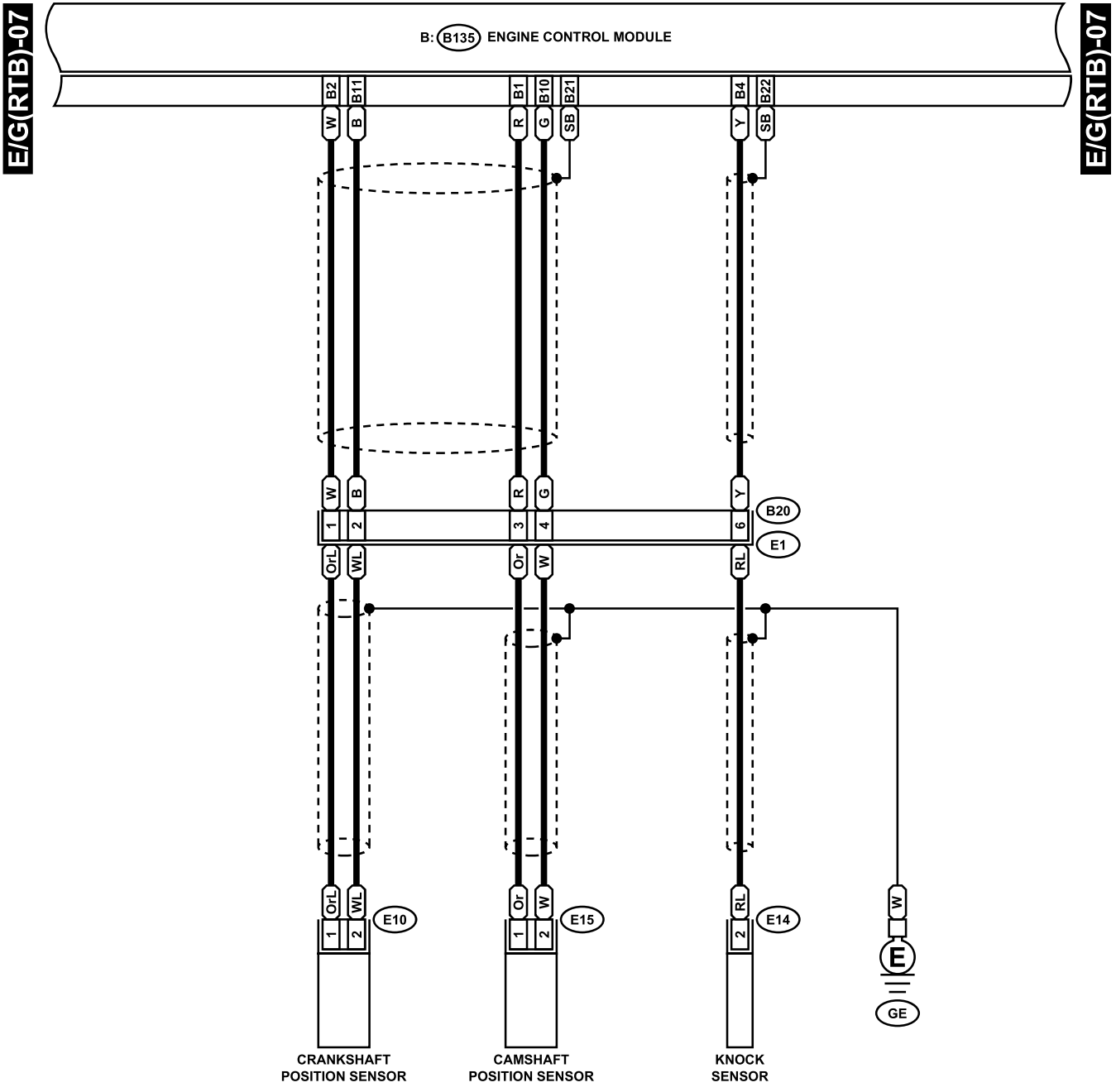

(E10) (LIGHT GRAY)

(B20) (LIGHT GRAY)

B: (B135)

(E14) (GRAY)

1	2	3	4
5	6	7	
8	9	10	

1	2	3	4	5	6	7	8	9	
10	11	12	13	14	15	16	17	18	19
20	21	22	23	24	25	26	27	28	

(E15) (LIGHT GRAY)

1	2
---	---

GR10-21G

ENGINE ELECTRICAL SYSTEM

WIRING SYSTEM

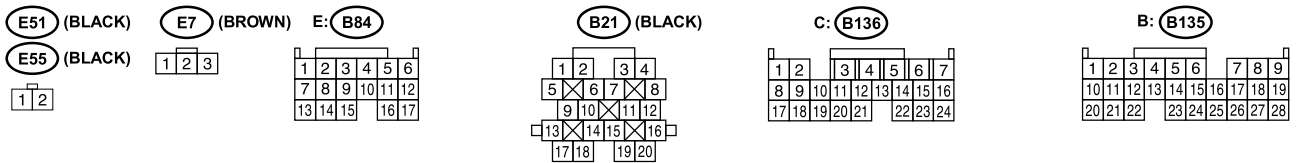
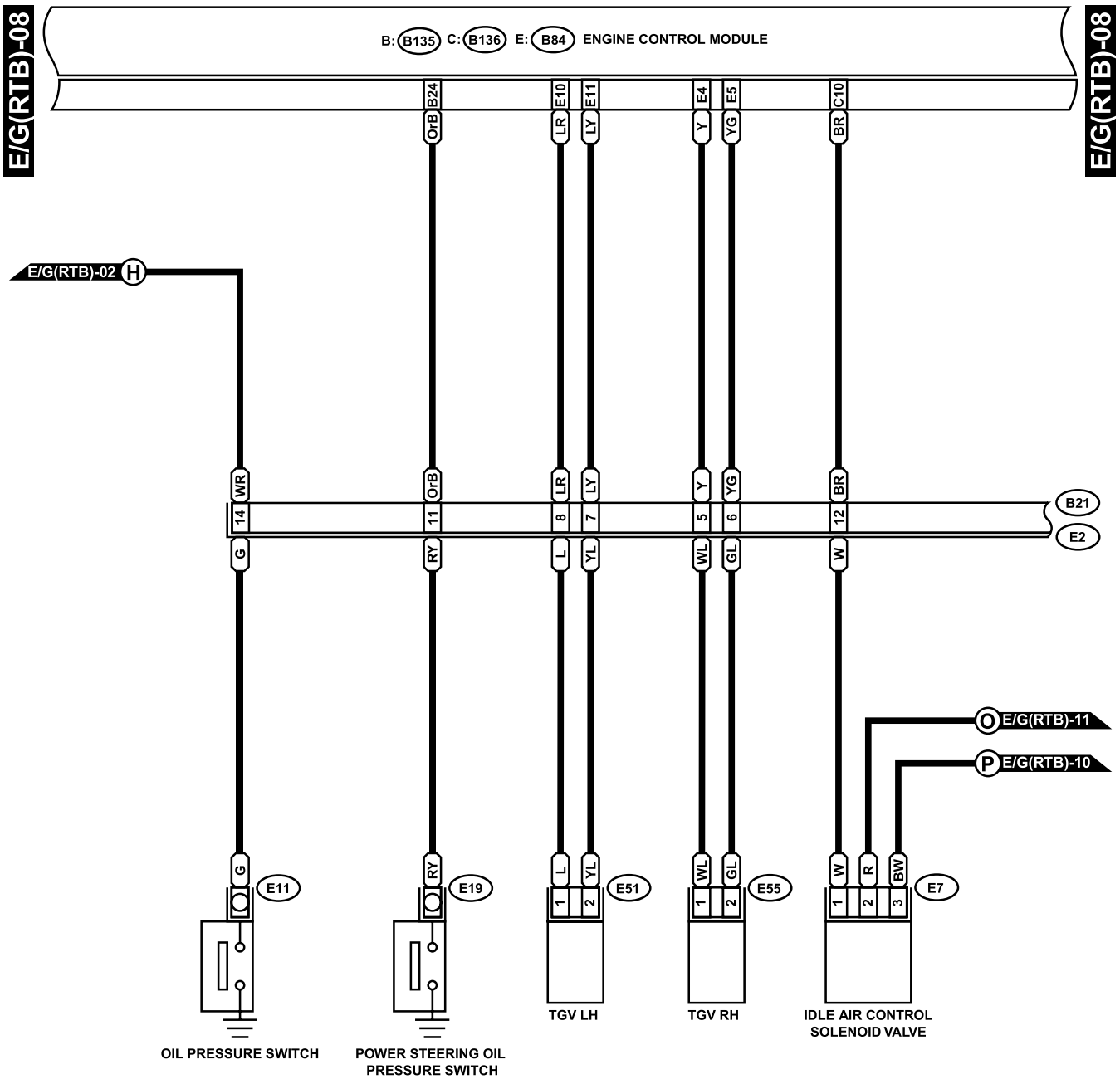

GR10-21H

ENGINE ELECTRICAL SYSTEM

WIRING SYSTEM

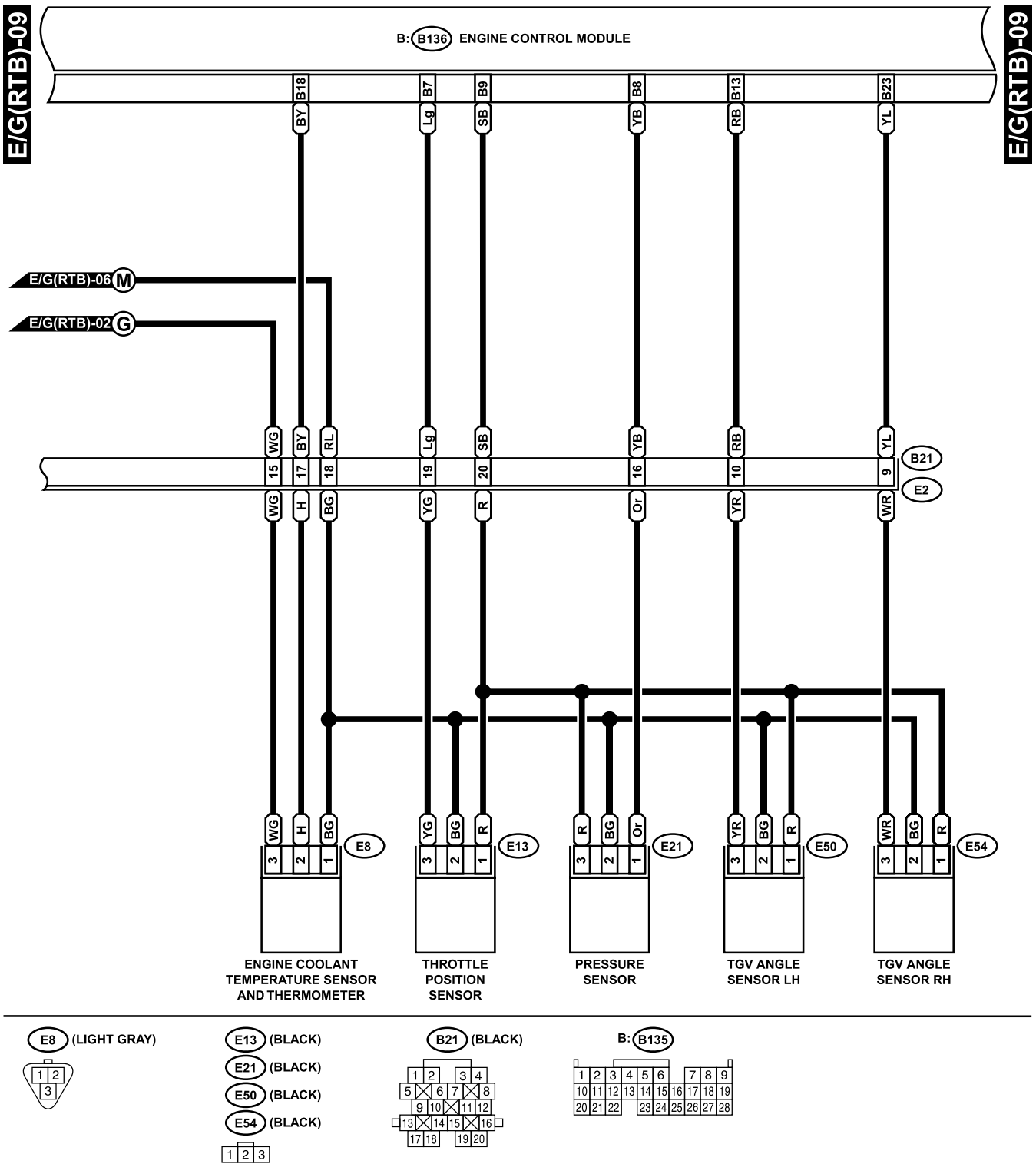

GR10-211

ENGINE ELECTRICAL SYSTEM

WIRING SYSTEM

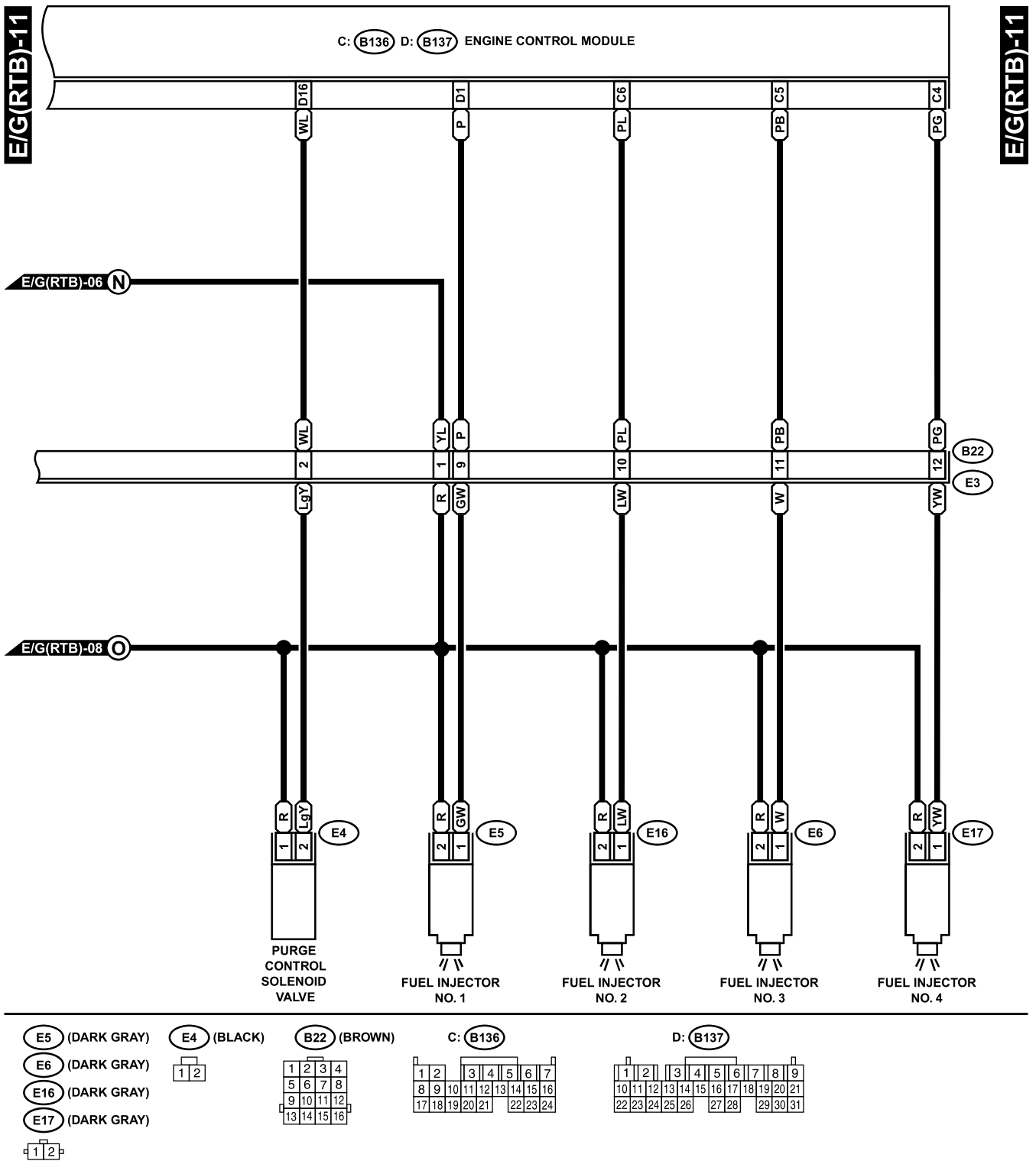

GR10-21K