

Audio System

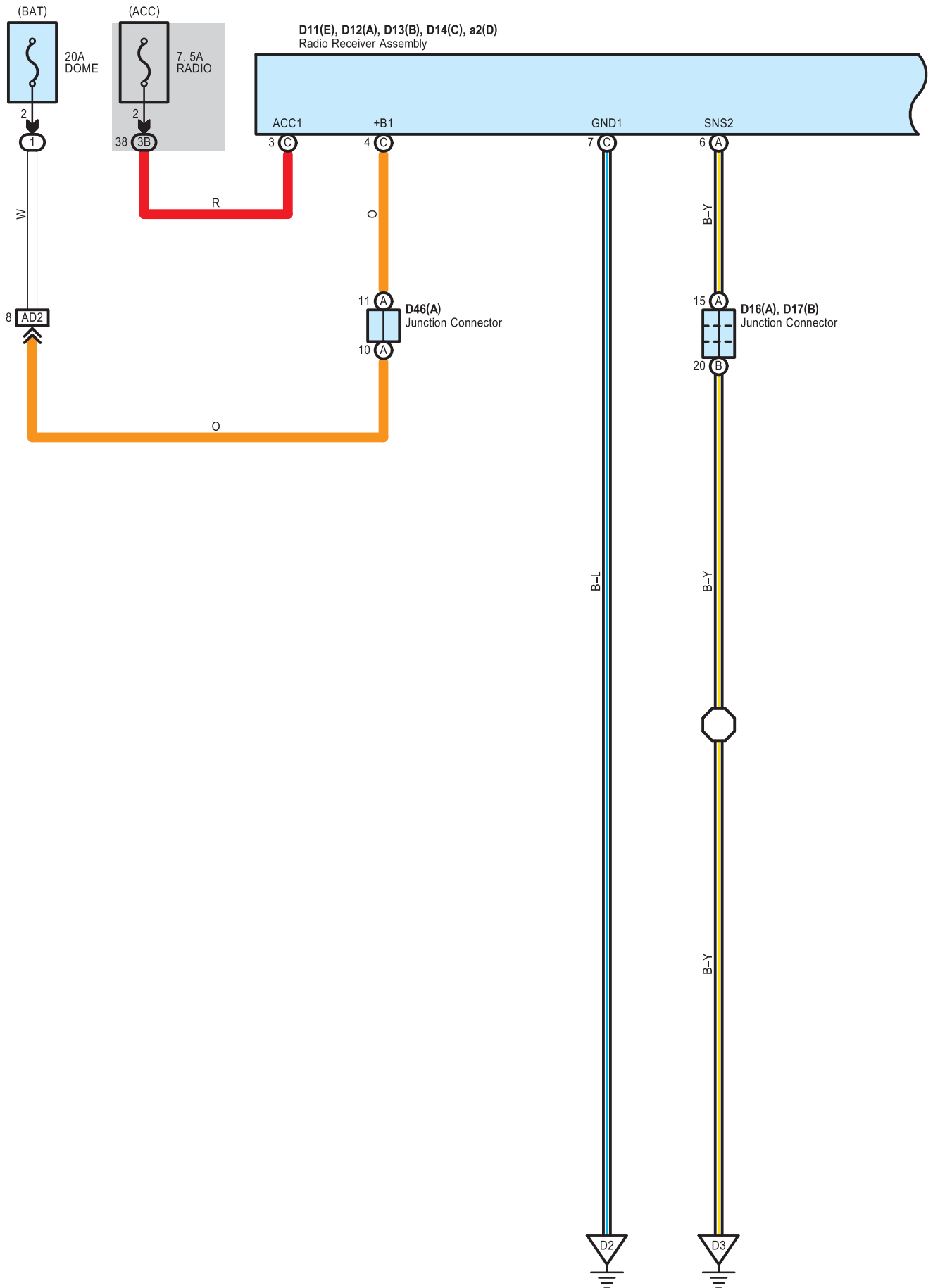

D11(E), D12(A), D13(B), D14(C), a2(D)
Radio Receiver Assembly

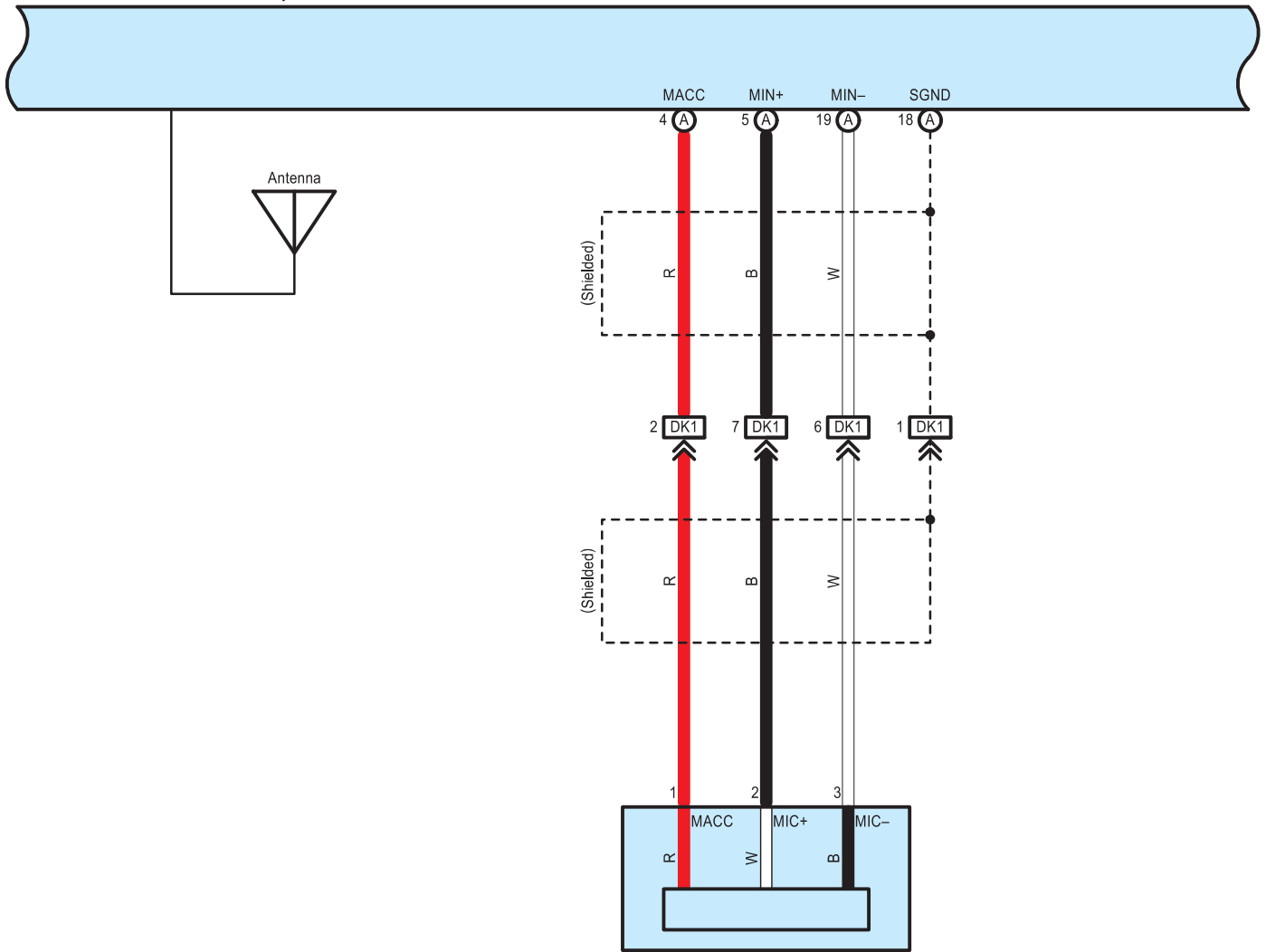

K4
Microphone Amplifier Assembly (Map Light Assembly)

Audio System

D11(E), D12(A), D13(B), D14(C), a2(D)
Radio Receiver Assembly

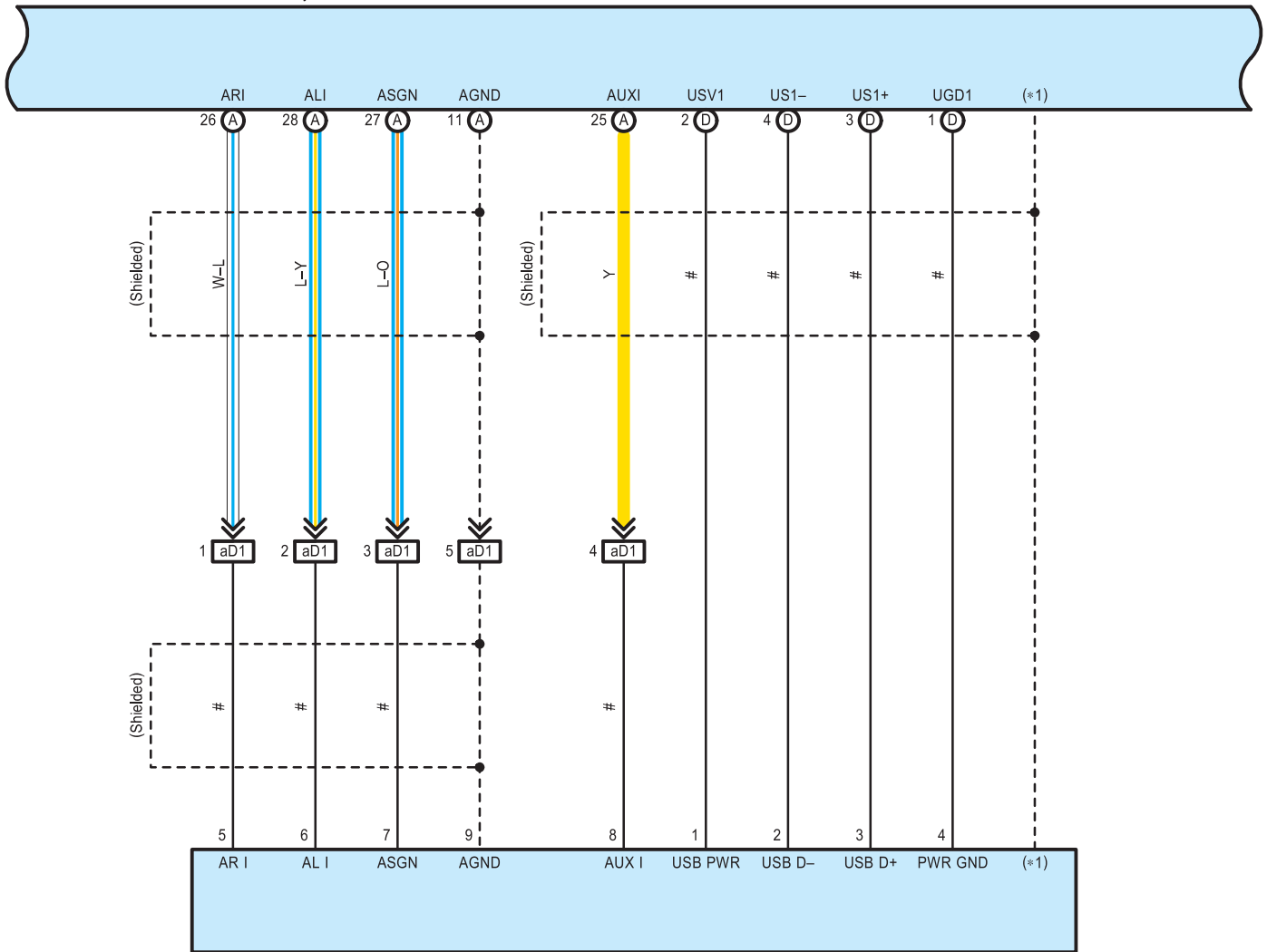

a1
No. 1 Stereo Jack Adapter Assembly

: There is no wire color information.

* 1 : Shielded Connector

D11(E), D12(A), D13(B), D14(C), a2(D)
Radio Receiver Assembly

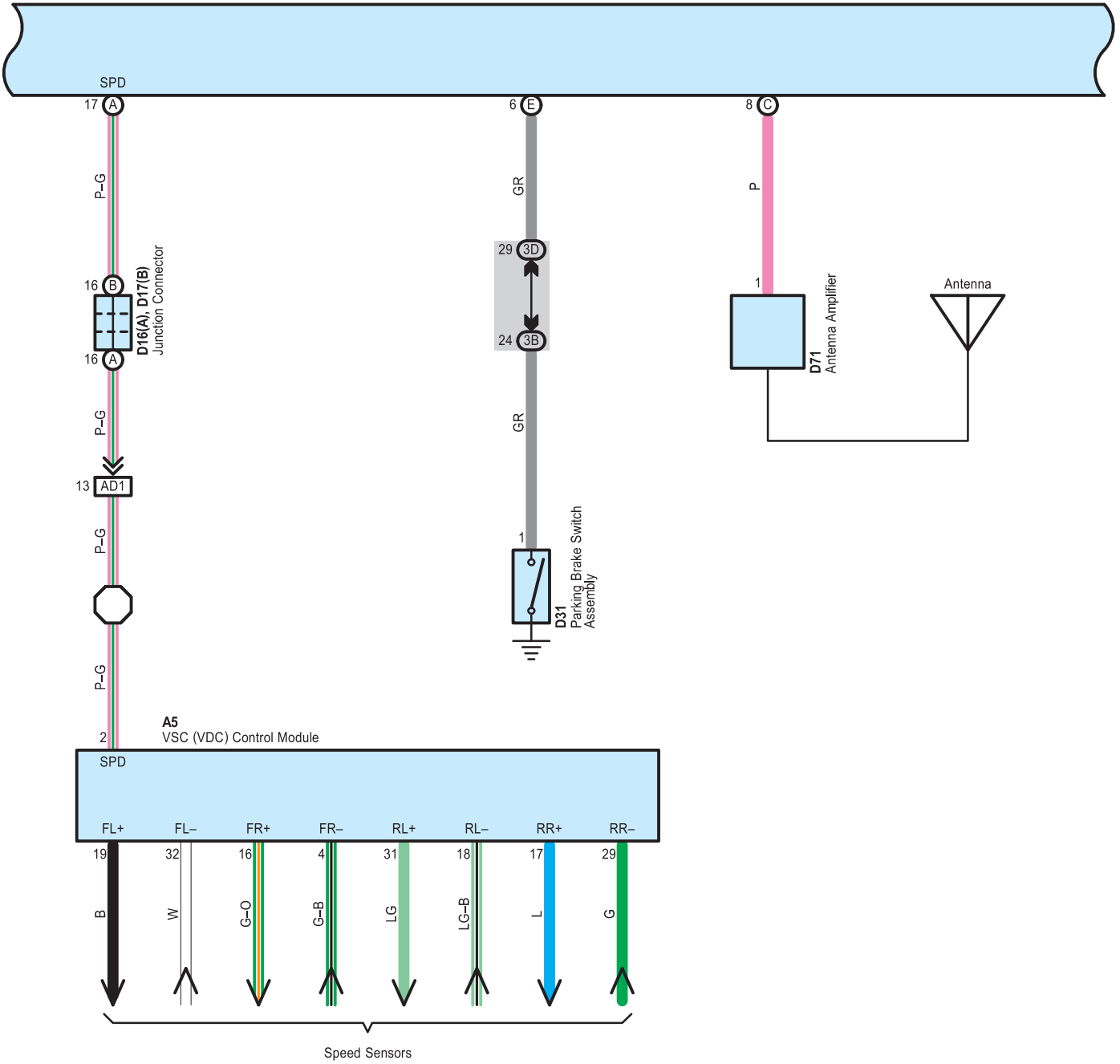

Audio System

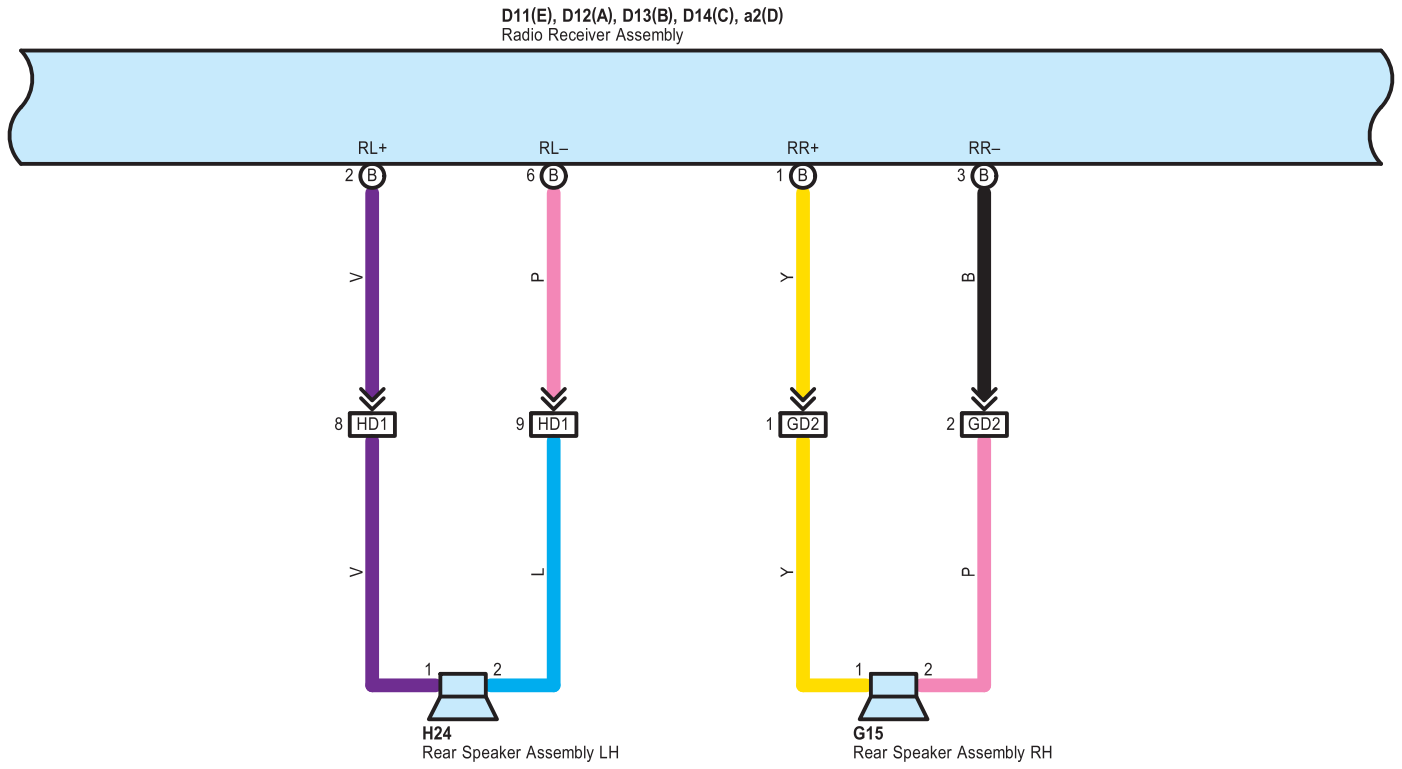

D11(E), D12(A), D13(B), D14(C), a2(D)
Radio Receiver Assembly

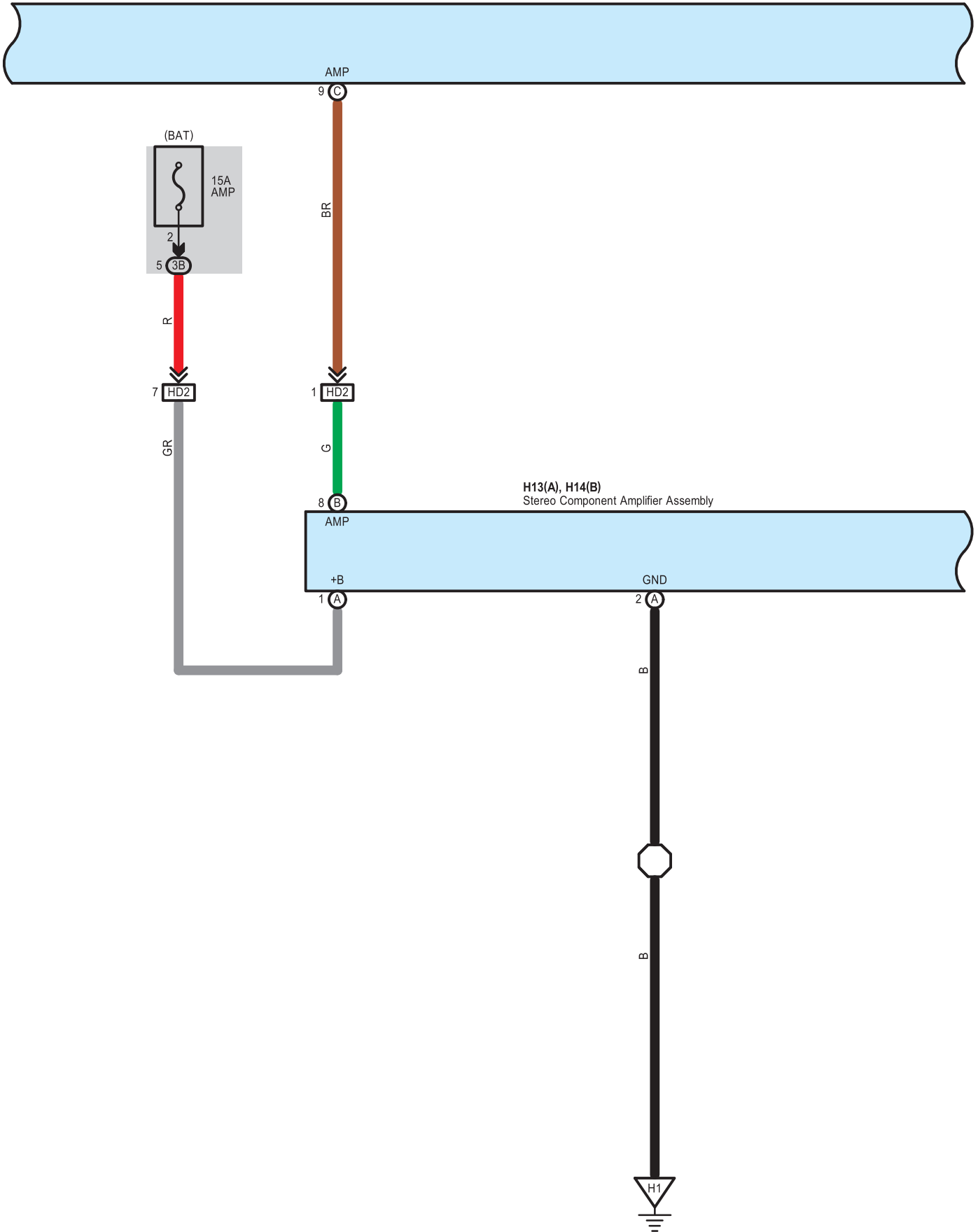

BRZ (G4410BE)

Audio System

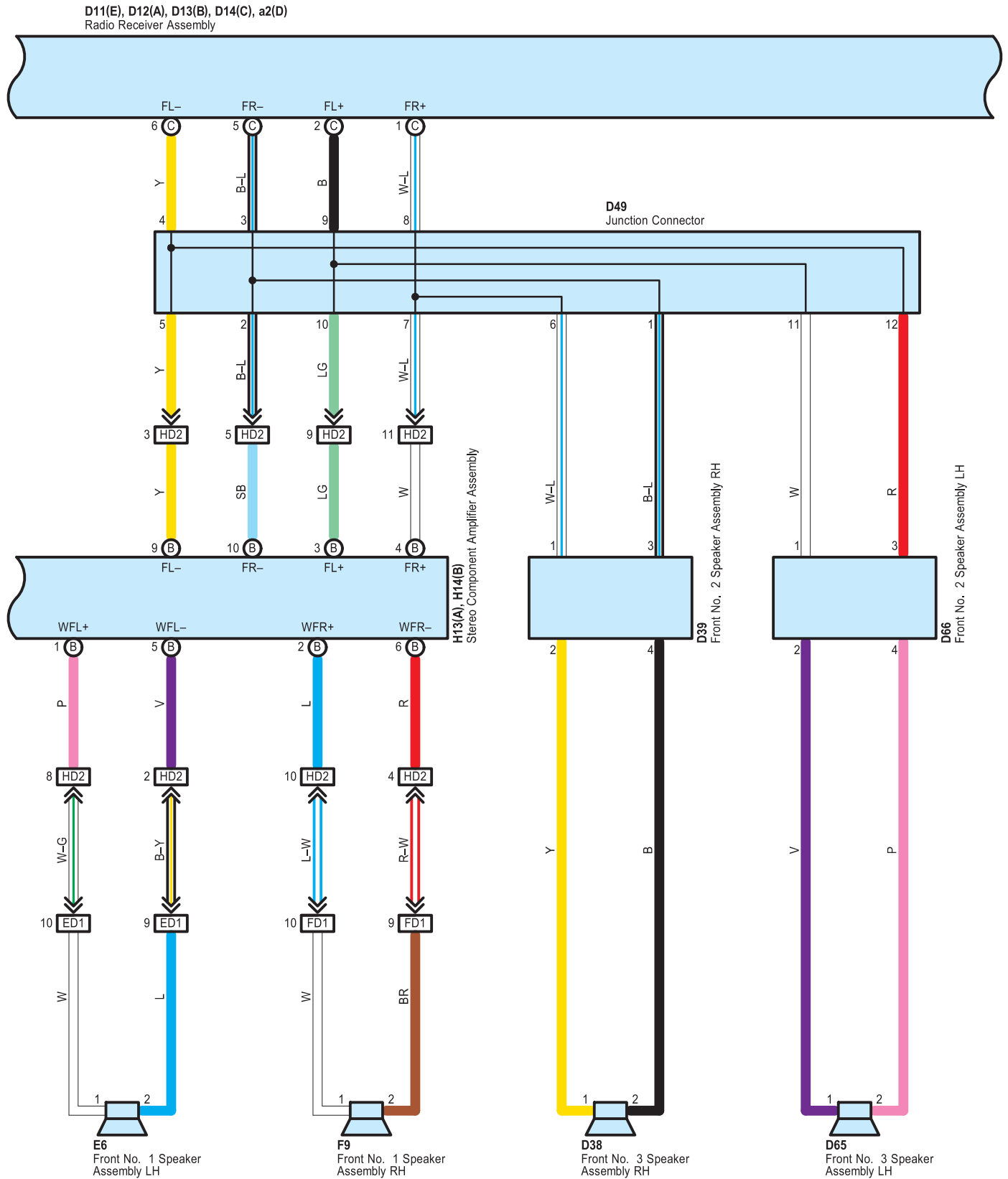

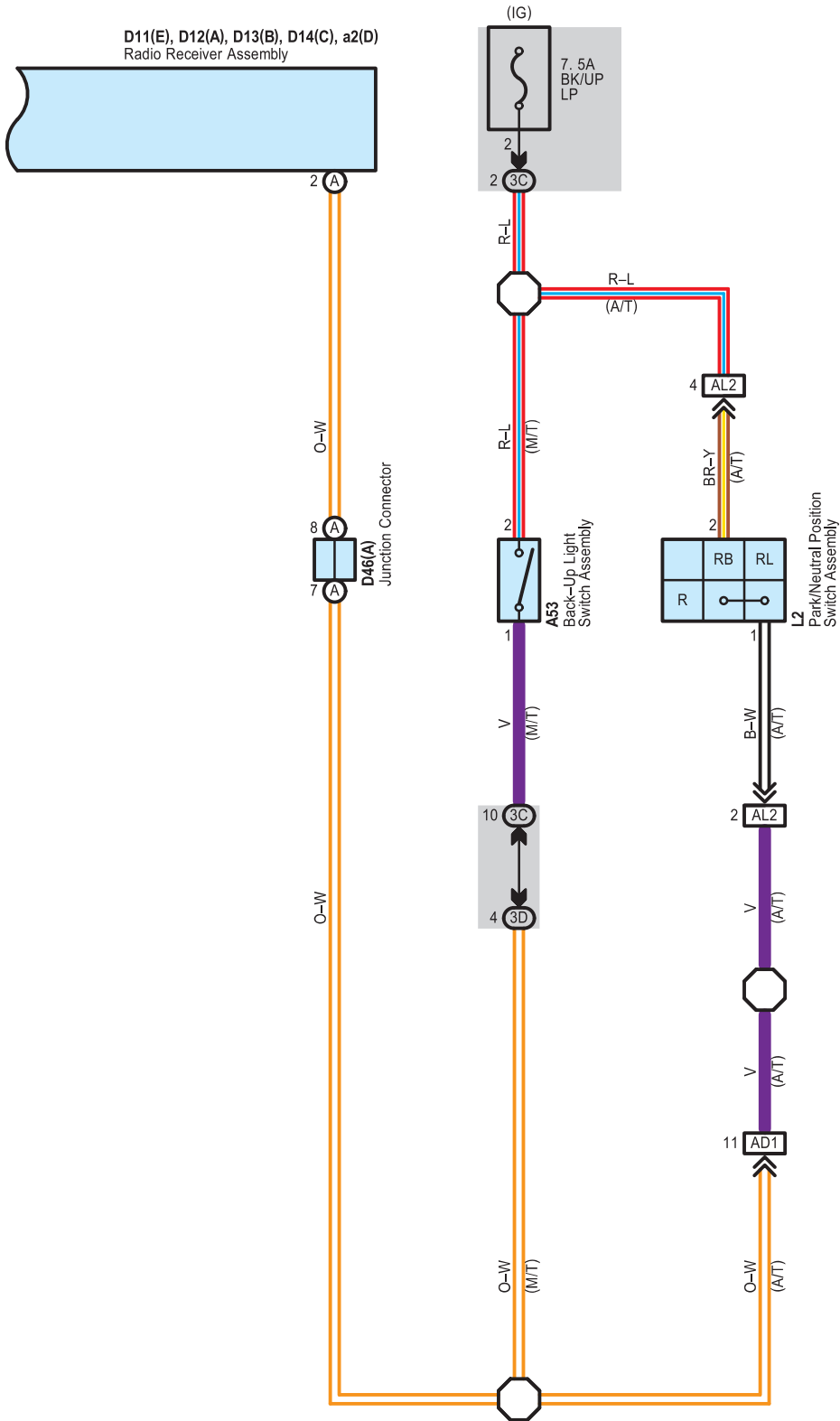

Audio System

: Parts Location

Code	See Page	Code	See Page	Code	See Page
A5	39	D38	40	G15	44
A53	39	D39	40	H13	A 45
D11	E 40	D46	A 41	H14	B 45
D12	A 40	D49	41	H24	45
D13	B 40	D65	41	K4	45
D14	C 40	D66	41	L2	39
D16	A 40	D71	41	a1	42
D17	B 40	E6	44	a2	D 42
D31	40	F9	44		

: Relay Blocks

Code	See Page	Relay Blocks (Relay Block Location)
1	24	Engine Room R/B (Engine Compartment Right)

: Junction Block and Wire Harness Connector

Code	See Page	Junction Block and Wire Harness (Connector Location)
3B	26	Instrument Panel Wire and Instrument Panel J/B Assembly (Instrument Panel Reinforcement)
3C	26	Engine Room Main Wire and Instrument Panel J/B Assembly (Instrument Panel Reinforcement)
3D	26	Instrument Panel Wire and Instrument Panel J/B Assembly (Instrument Panel Reinforcement)

: Connector Joining Wire Harness and Wire Harness

Code	See Page	Joining Wire Harness and Wire Harness (Connector Location)
AD1	47	Engine Room Main Wire and Instrument Panel Wire (Cowl Side Panel LH)
AD2	47	Engine Room Main Wire and Instrument Panel Wire (Cowl Side Panel RH)
AL2	46	Engine Room Main Wire and Transmission Wire (Dash Panel)
DK1	47	Instrument Panel Wire and Roof Wire (Front Body Inner Pillar RH)
ED1	47	Front Door Wire LH and Instrument Panel Wire (Cowl Side Panel LH)
FD1	47	Front Door Wire RH and Instrument Panel Wire (Cowl Side Panel RH)
GD2	47	No. 1 Floor Wire and Instrument Panel Wire (Cowl Side Panel RH)
HD1	47	No. 2 Floor Wire and Instrument Panel Wire (Cowl Side Panel LH)
HD2		
aD1	47	Instrument Panel Wire Assembly and Instrument Panel Wire (Around A/C Unit)

: Ground Points

Code	See Page	Ground Points Location
D2	47	Instrument Panel Brace LH
D3	47	Instrument Panel Brace RH
H1	48	Lower Back Panel